

OLYMPUS

Your Vision Our Future

RESEARCH STEREOMICROSCOPE SYSTEM

SZX16 / SZX10

SZX2



For **B**iological Use

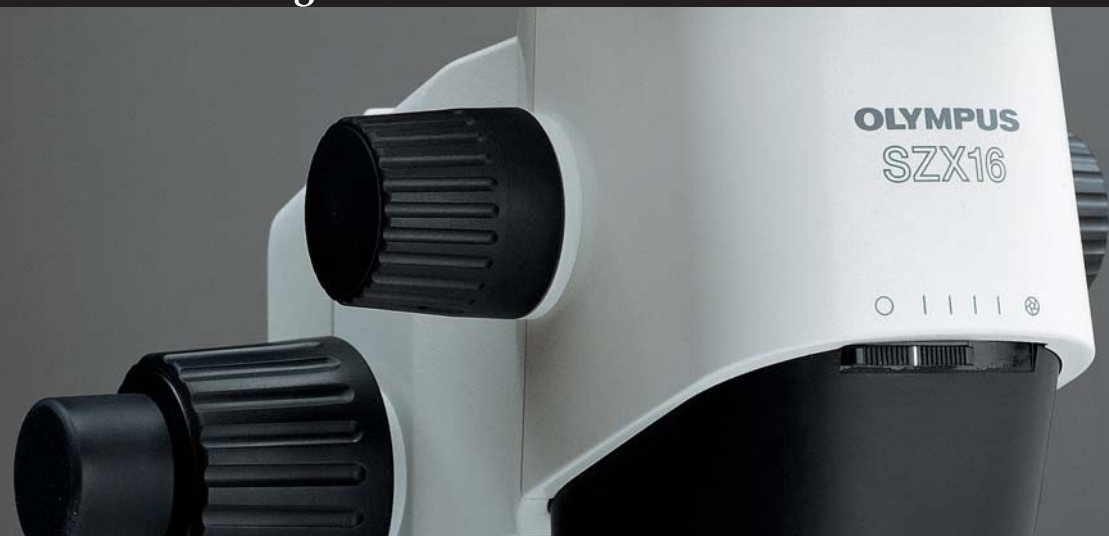

Reaching a new dimension of microscopy — beyond the imagination.

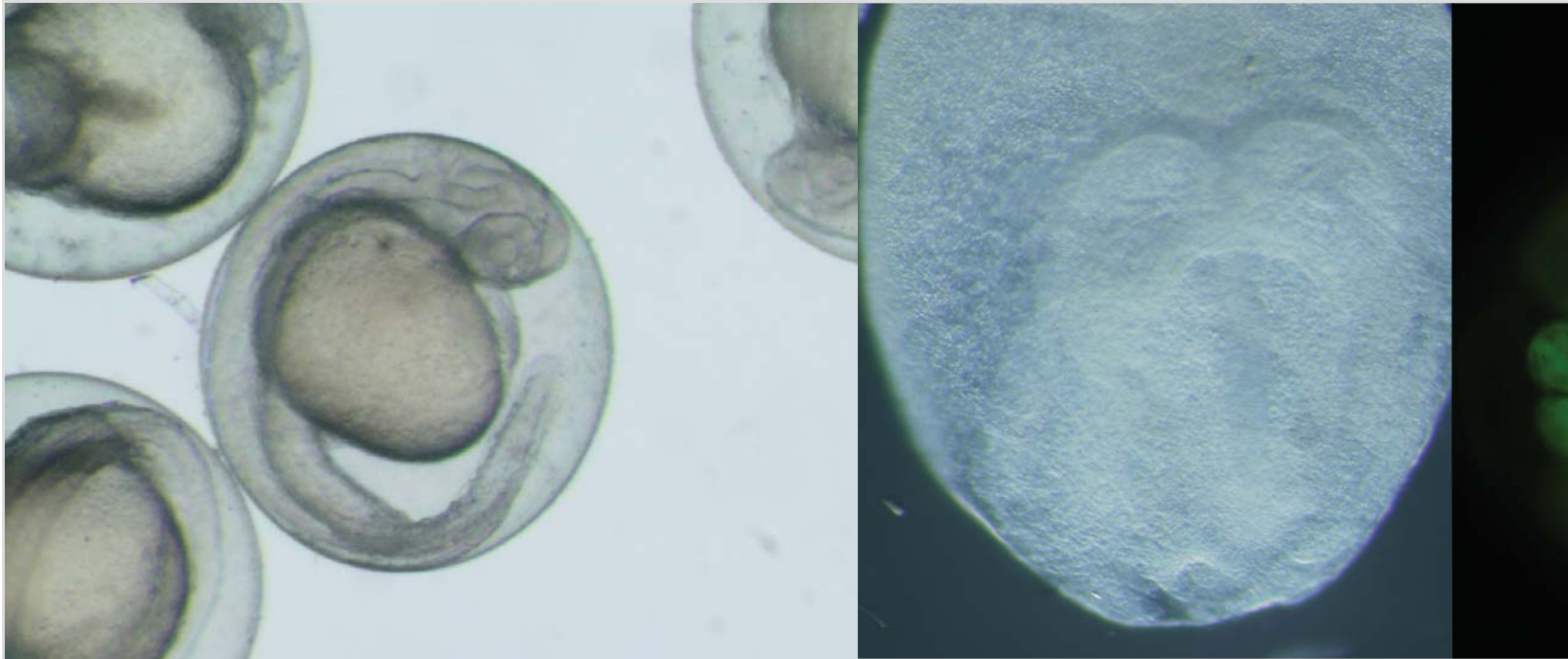

Olympus expertise raises stereomicroscopes to a new level with the world's highest zoom ratio* and maximum numerical aperture (NA). Unmatched image clarity and a highly flexible optical system assure operational ease. The SZX2 Research Stereomicroscope System reveals a new world, far beyond expectations.

Cutting-edge biological and medical laboratories are environments that require the most effective imaging and observation of a vast quantity of live specimens. By meeting these needs, the research stereomicroscope system has advanced. Pursuant to its mission of "looking into the world of the unknown", the SZX2 Stereomicroscope Series has been refined to a higher level of quality and performance that redefines the possible for stereomicroscopes.

Superb optical performance and maximum comfort have therefore been realized. Image clarity exceeding that of conventional stereomicroscopes derives from unprecedented high resolution achieved by the highest available NA and a depth of field perceived as deeper from multi-wave length astigmatism-free design that absolutely minimizes astigmatism. SZX2 is ergonomically redesigned especially to reduce fatigue and to provide ultimate ease of use for long-time observation and other tasks. SZX2 opens the door for you to a new world, untouched and unseen.

*Olympus finding, as of March 31, 2006.



SZX16

P03-P08

A new dimension in image clarity

Unparalleled sharp viewing is the result of a multi-wavelength, astigmatism-free design that absolutely minimizes aberration and the world's highest NA. From low to high magnification, unprecedented bright and even fluorescence observation is achieved.

P09-P10

Comfortable operability

Long working distance (WD) and high NA are featured. Overall work efficiency is assured, including the illumination base design.

P11-P12

Ergonomic design for working ease

Tilting trinocular tube, with an optimum convergence angle and new slim illumination base, effectively eliminates fatigue resulting from long-time observation and other tasks.

P13-P14

Digital imaging

From brightfield to fluorescence observation, image acquisition of various specimens is possible at high resolution.

P15-P16

Equipment answering various needs

Accessories for maximizing optical performance and operability include a variety of illumination bases, light guides, and stage plates.



Olympus' new SDF objective lenses provide the highest NA with 900lp/mm resolution. Optimum specimen viewing from large field overview to microstructure, along with instant zoom function to select observation points, is assured.

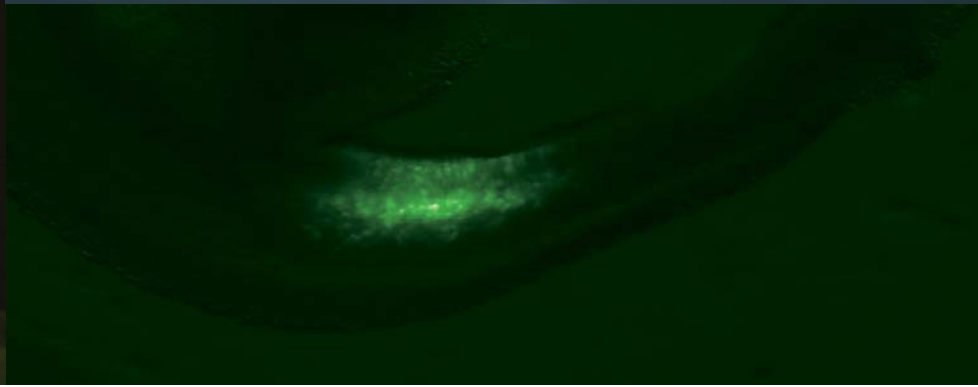
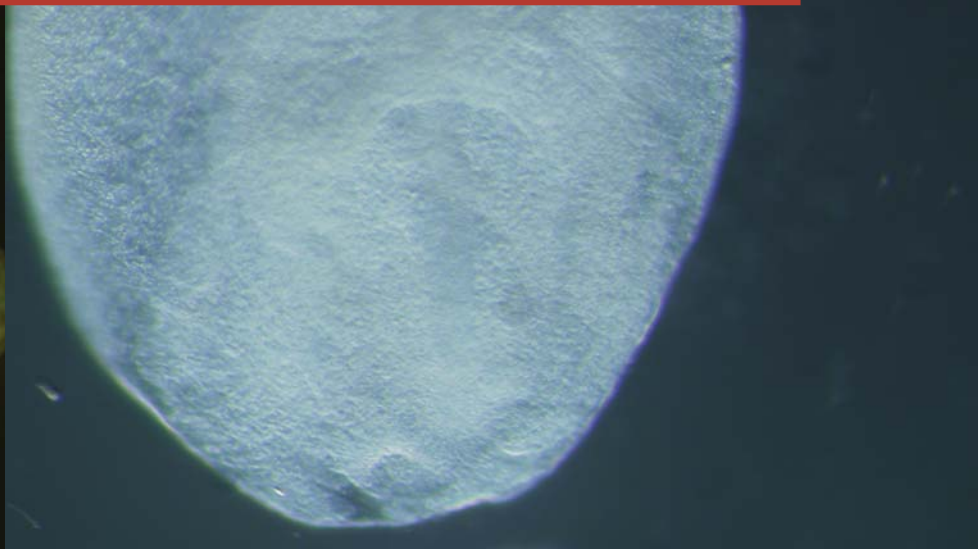
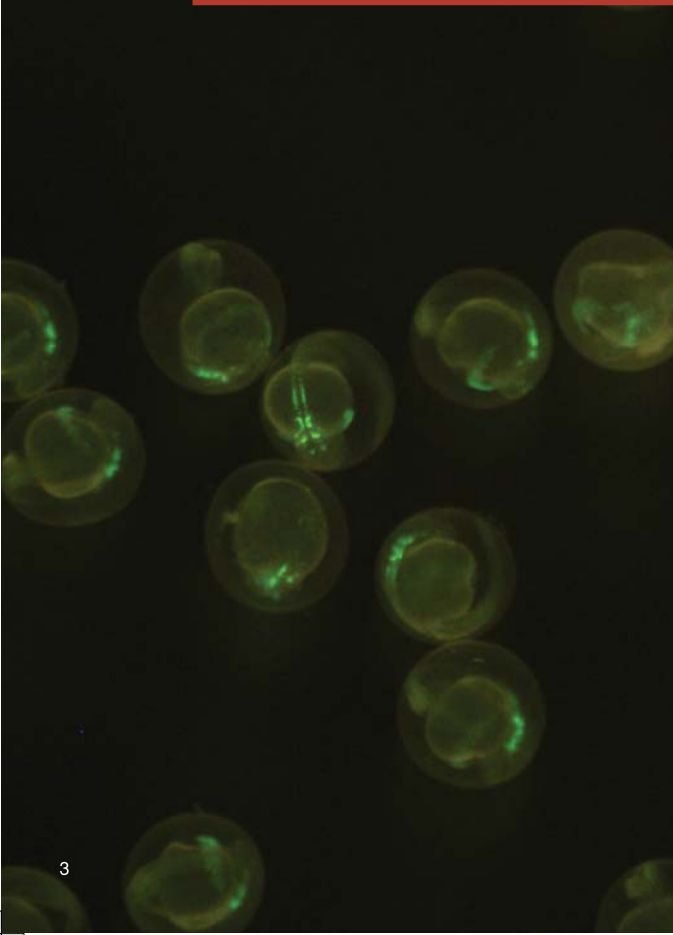

The world's highest zoom ratio of 1:16.4 is achieved. From low to high magnification, several different observation tasks are available on one microscope.

The SZX16 offers optical performance at the highest global standard. SDF objective lenses with the highest available NA enable microstructural observation that could not be achieved before. And with the world's highest zoom range of 7.0x-115x, this all-in-one microscope answers a wide range of needs related to operation at low magnifications to detailed observation at high magnifications. These outstanding features meet the need for clear observation of transparent specimens of minimal contrast to microstructural viewing. Manipulation of live specimens has never been easier.

■ Highest available NA

The SZX16 realizes the highest NA (0.3) among stereomicroscopes with 2x objectives. Optical performance is 30% better than that of comparable products and allows for significantly more image information.

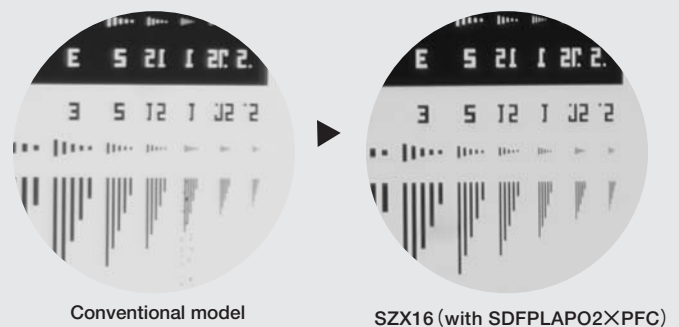

■ SDF lineup: six objectives for various uses

The broad lineup of the SZX16 PLAN APO objective series covers several needs with features ranging from long WD objectives for operations requiring wide working space (such as sample acquisition or selection) to high magnification objectives with the world's highest NA for microstructural observation.

Model	WD (mm)	Magnification*
SDFPLFL0.3X	141	2.1x-34.5x
SDFPLAPO0.5XPF	70.5	3.5x-57.5x
SDFPLAPO0.8X	81	5.6x-92x
SDFPLAPO1XPF	60	7x-115x
SDFPLAPO1.6XPF	30	11.2x-184x
SDFPLAPO2XPFC	20	14x-230x

*Using WHN 10X-H



SDF Objective Lens Series

■ World's highest zoom ratio for several observation tasks

With a zoom range of 7.0x-115x (using SDFPLAPO 1X and WHN10X-H), the SZX16 has the world's highest zoom ratio of 1:16.4. From sample verification and selection at low magnification to microstructure verification at high magnification, seamless observation is available.

■ Two objectives combine with revolving nosepiece for 3.5x – 230x zoom

The Parfocal (PF) Series of 0.5x, 1x, 1.6x, and 2x comprises four PF objectives. The revolving nosepiece allows easy switching between two objective lenses and smooth zooming between 3.5x and 230x (using WHN10X-H).



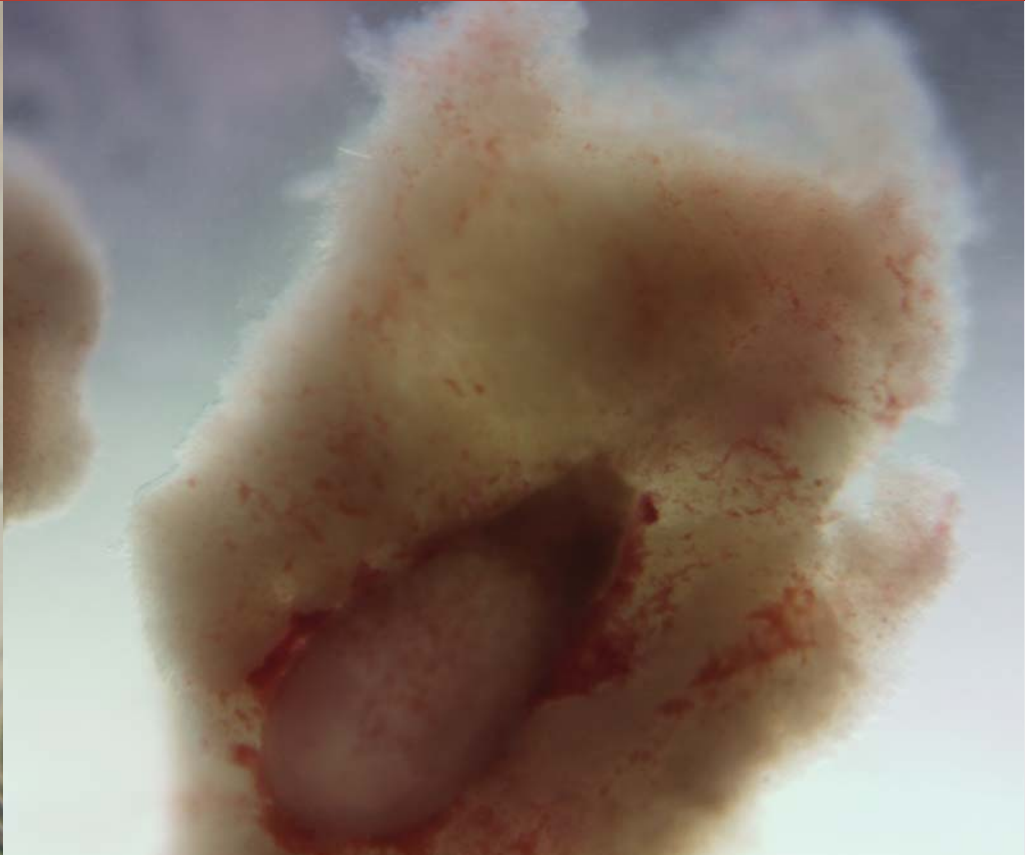

Unprecedented depth and sharp images dramatically enhance efficiency for a variety of tasks including specimen manipulation.

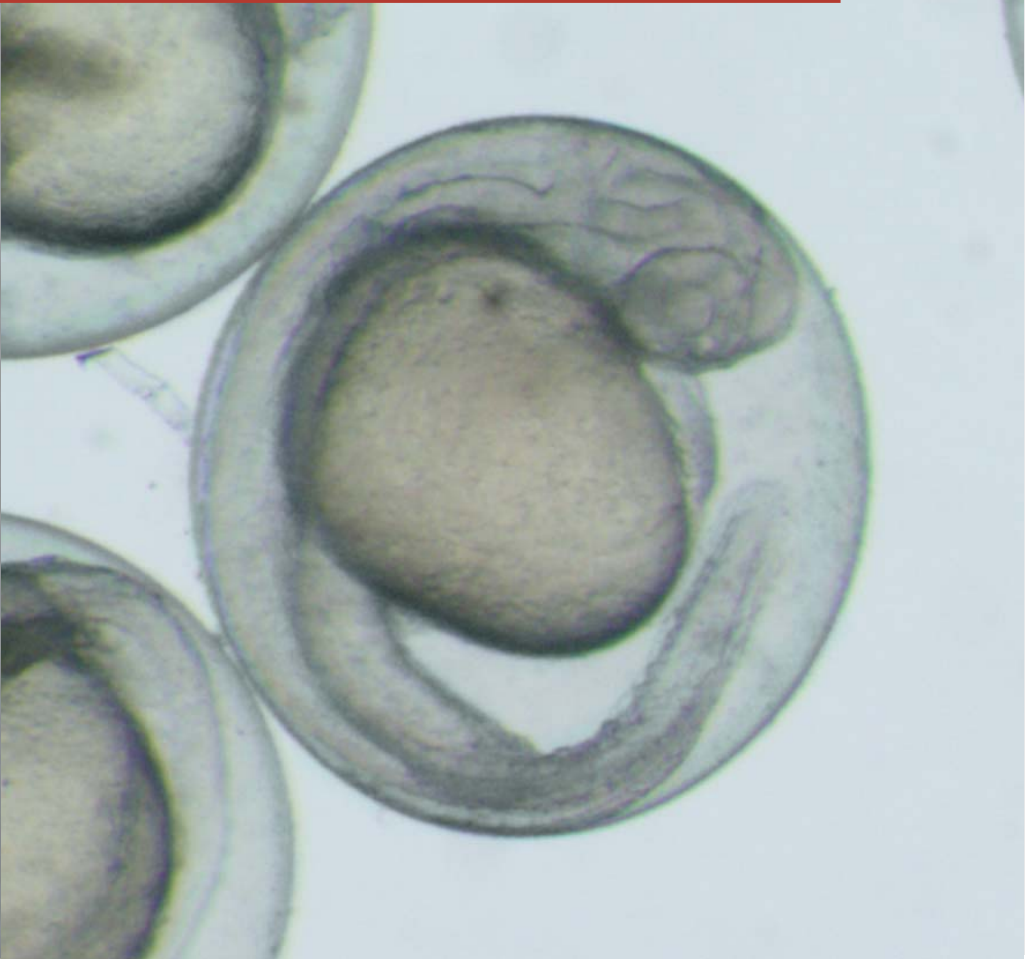

Multi-wave length, astigmatism-free design for sharp 3D observation. New standards in image clarity begin with this design.

“Multi-wave length astigmatism-free”: a new design effectively eliminating image-deforming aberration and enabling remarkably sharp 3D imaging and dramatically enhanced specimen manipulation. Also, with an apochromatic lens system that effectively reduces chromatic aberration, the latest proprietary SZX 16 optical system provides sharp 3D observation images of various specimens.

Sharp, detailed observation of specimens

Newly designed SDF objective lenses keep astigmatism to a minimum. This effectively eliminates image deforming at pre- and post-focal plane and thus the depth of field is perceived as deeper than before. These design features enable stress-free use of forceps in the field of view during live sample selection and acquisition. SZX2 puts power into action for long-time observation. When these objectives are combined with the newly developed transmitted light illumination base, clear observation is even possible for transparent specimens where contrast is low. Oversights are thus minimized for specimen selection, dissection, and manipulation.

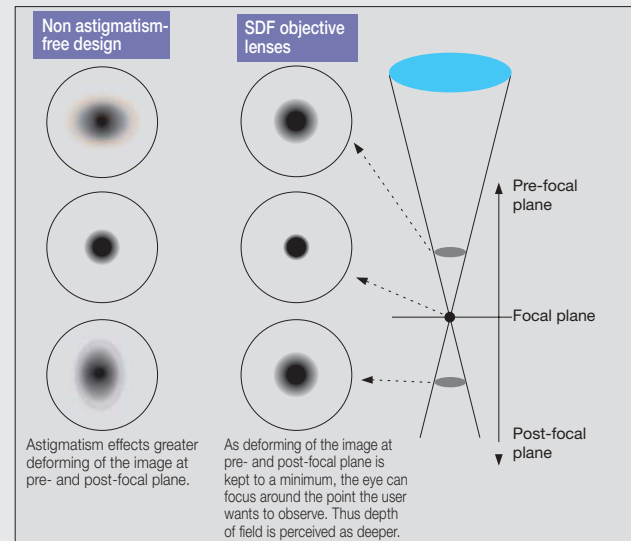

• Depth of field seen in focal plane will vary according to individual differences in users' vision.

Integration of apochromatic system

The apochromatic system — integrated into observation tubes, zoom body, and objectives — eliminates chromatic aberration throughout the zoom range and ensure excellent image quality without chromatic blur.



Optical performance with less fatigue

A 360° view of balanced images is made possible by accommodating vertical and horizontal parameters. Discomfort in the eyes and body, as well as stress from prolonged observation or operation, is effectively eliminated.

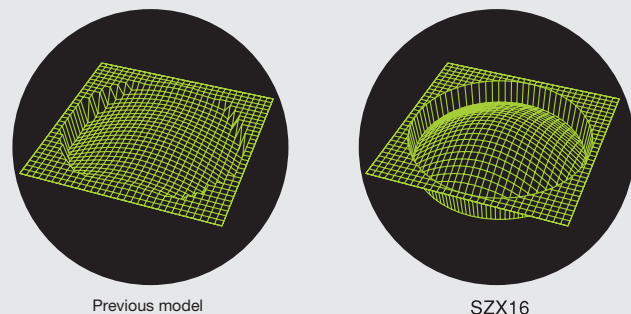

SZX16: new optics for equally easy handling of thick specimens

Obtaining a lucid visual perspective, such as a clear feel for dimension, is essential for manipulation of thick specimens like eggs or embryos. The latest proprietary SZX16 delivers the images needed for observation of such specimens. 3D observation images from surface to interior are also particularly effective in the dissection and manipulation of live specimens.

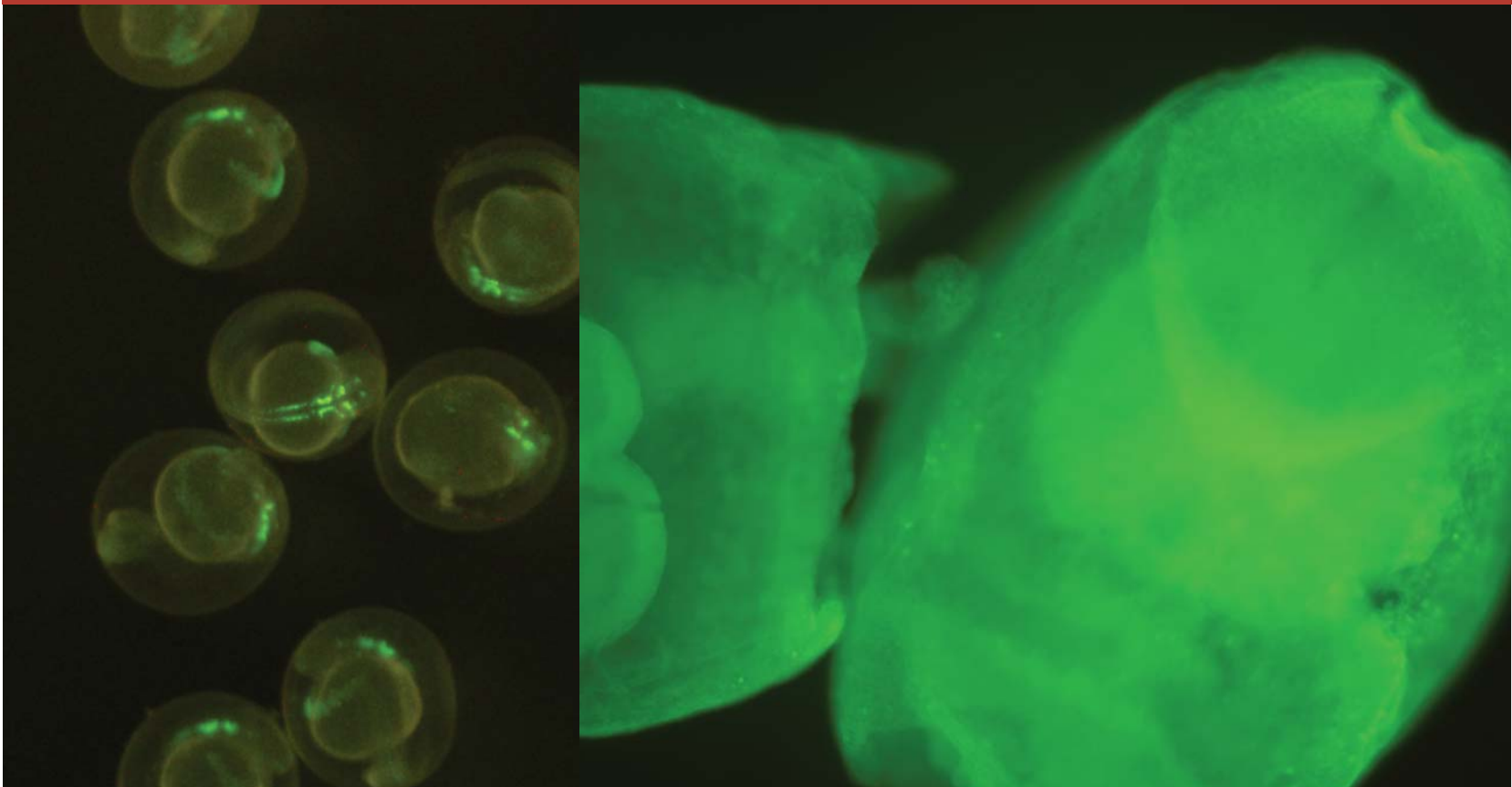

From low to high magnification, exceptionally bright and even fluorescence is assured for efficient screening.

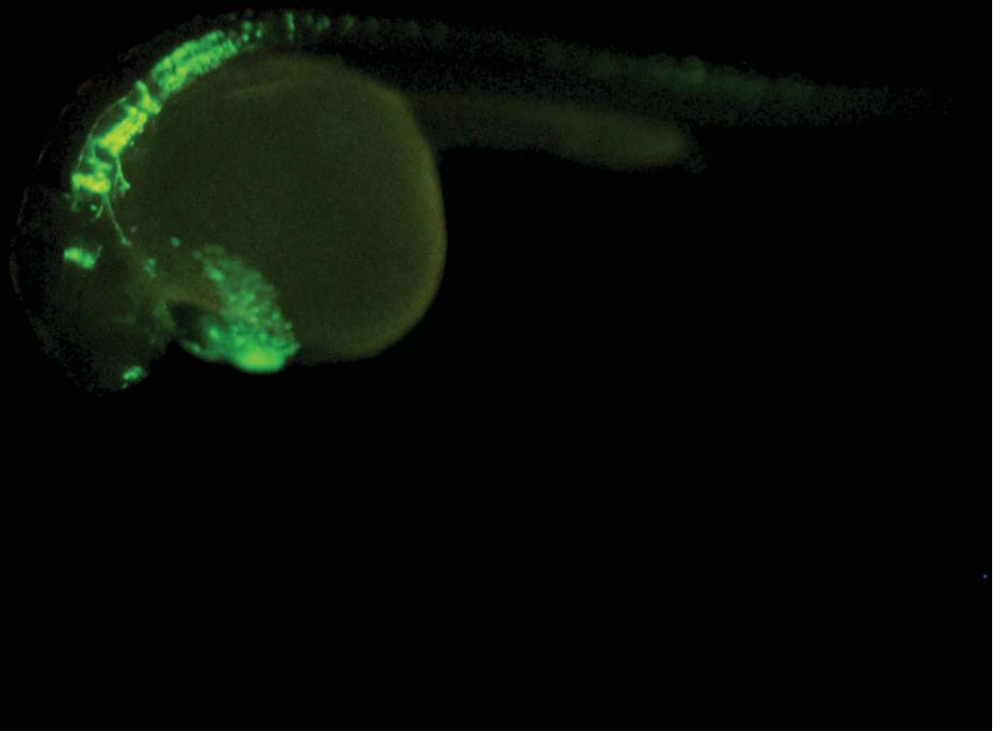
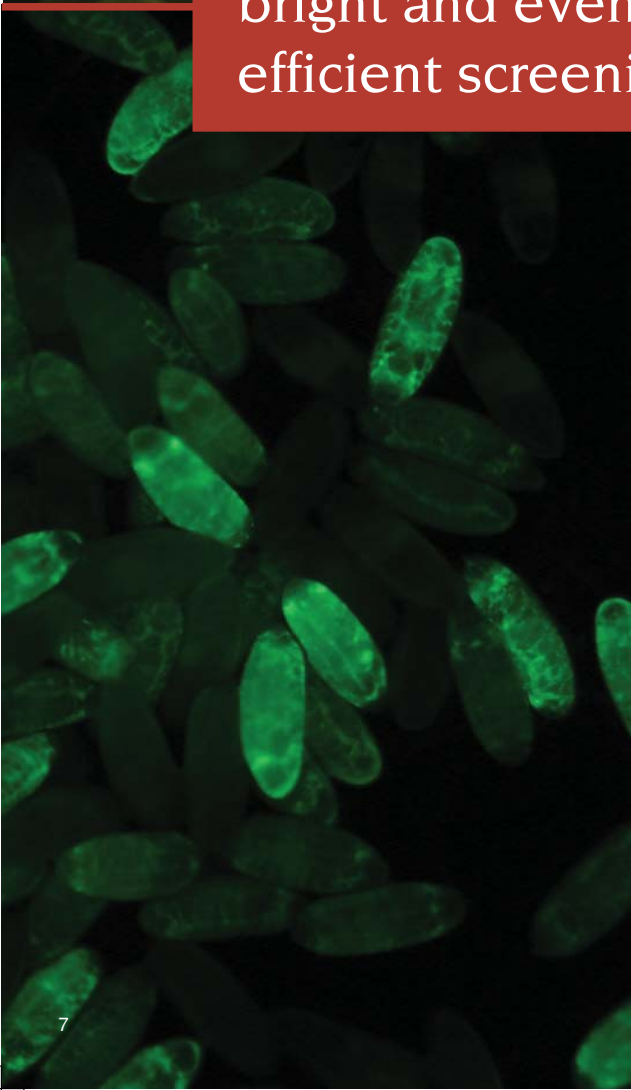

Newly designed SDF objective lenses of the highest NA and Olympus' newly developed near-vertical reflected light illuminator will significantly improve signal intensity and support bright fluorescence observation.

Bright fluorescence observation is essential in recent biological and medical research. Observation of weak fluorescence at low magnification under stereomicroscope has especially been a problem. However, the SZX16 enables even and overwhelmingly bright fluorescence observation from low to high magnifications.

■ Highest NA among stereomicroscopes provides extraordinarily bright fluorescence observation

SDF objective lenses of the highest NA dramatically improve fluorescence detection sensitivity. Furthermore, the newly designed near-vertical reflected light illuminator's excitation light paths are independent from the observation paths, allowing for substantially improved excitation light efficiency. These features provide far brighter fluorescence observation than conventional stereomicroscopes at all magnifications. Transmitted light observation for verification of specimen outline is possible even under reflected light fluorescence observation.

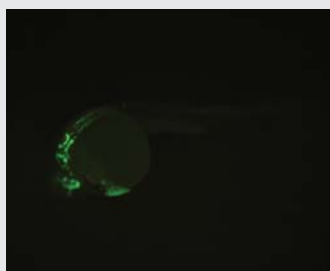

Fluorescence illumination only

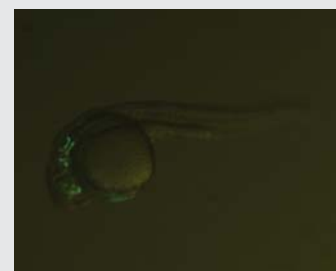

Fluorescence and transmitted light illumination

■ Even and seamless fluorescence observation from low to high magnification

In correspondence with zoom function, the reflected light illuminator provides even illumination from low to high magnification. This will eliminate oversights along the periphery of the field of view during live specimen screening and dramatically improve work efficiency.

■ Five-position turret with nine-filter selection

Nine filter units, ranging from UV excitation to RFP, respond to applications using various fluorescent dyes and protein. Olympus High Quality (HQ) filters have an edge steepness and high transmission that efficiently detect the light of fluorescence to enhance and capture brighter fluorescence images in precise detail.



SZX16 reflected light fluorescence illumination stand

Filter unit	Model	Remarks
For UV excitation	SZX2-FUV	Ex330-385/Em420-
For BV excitation	SZX2-FBV	Ex400-440/Em475-
High performance for CFP	SZX2-FCFPHQ	Ex425-445/Em460-510
For GFP	SZX2-FGFP	Ex460-490/Em510-
For GFP separation	SZX2-FGFPA	Ex460-495/Em510-550
High performance for GFP	SZX2-FGFPHQ	Ex460-480/Em495-540
High performance for YFP	SZX2-FYFPHQ	Ex490-500/Em510-560
For RFP 1	SZX2-FRFP1	Ex530-550/Em575-
For RFP 2	SZX2-FRFP2	Ex540-580/Em610-



SZX16 Fluorescent filter unit

CLICK
CLICK STOP

OLYMPUS
SDF PLAPO 1XPF
JAPAN

Effective combination of long WD and high NA.
Development of an ergonomic design.
Design focus on creating a wide working space and comfort.

Operability configured as a whole-system characteristic. Design is focused not only on WD and NA, but also on a stage that is slim.

SZX2 responds well to a variety of specimens and operations — from large specimens like mice to small ones like zebra fish, nematode or drosophila eggs — because of the effective combination of high numerical aperture and wide working space. Moreover, the transmitted light illumination base is newly designed thin (only 41mm) to provide a wide working space and allow various users to work comfortably.

Wide working space and high NA

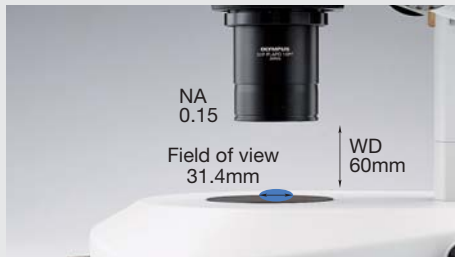

WD60mm and NA0.15 from the 1x objective

The 1x objective has a WD (60mm) that gives the user room to move and an NA (0.15) that meets the needs of advanced research. Also available are 0.8x objectives that have a longer WD of 81mm, which provides not only a larger working space between objective lenses and sample but also a total magnification of 5.6x-92x (using WHN10x-H).



2x objectives with ease of access and correction collar

A highly flexible design assures a wide access angle to objectives with the highest NA (0.3) for specimen selection. An additional correction collar can adjust image quality independently of the specimen — a first in stereomicroscopes.

Ergonomic design for user-friendly base

Offering a wide working space in which users can place several Petri dishes, these illumination bases have an ergonomic, beveled design for users to work comfortably and naturally.

High-level transmitted light illumination base (SZX2-ILLB)

This unit provides effective contrast from oblique illumination and easily selected “High” and “low” contrast settings. Light volume and color temperature are adjusted by means of built-in filters (LBD/ND). It also has a cooling fan to prevent overheating of the base surface.



Brightfield/darkfield transmitted light illumination base (SZX2-ILLD)

This base enables darkfield observation under illumination twice as bright as conventional models. Flat and thin specimens like brain tissue slices are vividly displayed on a black background. A cooling fan prevents the illumination base surface from overheating.

Transmitted light illumination base (SZX2-ILLK)

Offering outstanding cost-efficient performance, this illumination base uses oblique illumination to provide high-contrast images of transparent specimens.

Slim 41mm LED illumination base

Slim LED transmitted light illumination base (SZX2-ILLT)

With a slim design of 41mm — approximately half that of conventional models — the SZX16 transmitted light illumination base has a lower height to enable a low eyepoint and easy access to base-mounted samples during observation and operation. The world’s first LED 4-position turret enables contrast adjustment between brightfield, oblique, and darkfield illumination with a simple turn. This makes the SZX16 the all-in-one microscope for various samples and observation tasks. Another advantage of LED illumination is keeping down the temperature of the base surface, which is suitable for long-time manipulation of live specimens. Power consumption is about half that of a conventional 30W Halogen light source. A life cycle of over 10,000 hours significantly reduces operation costs.

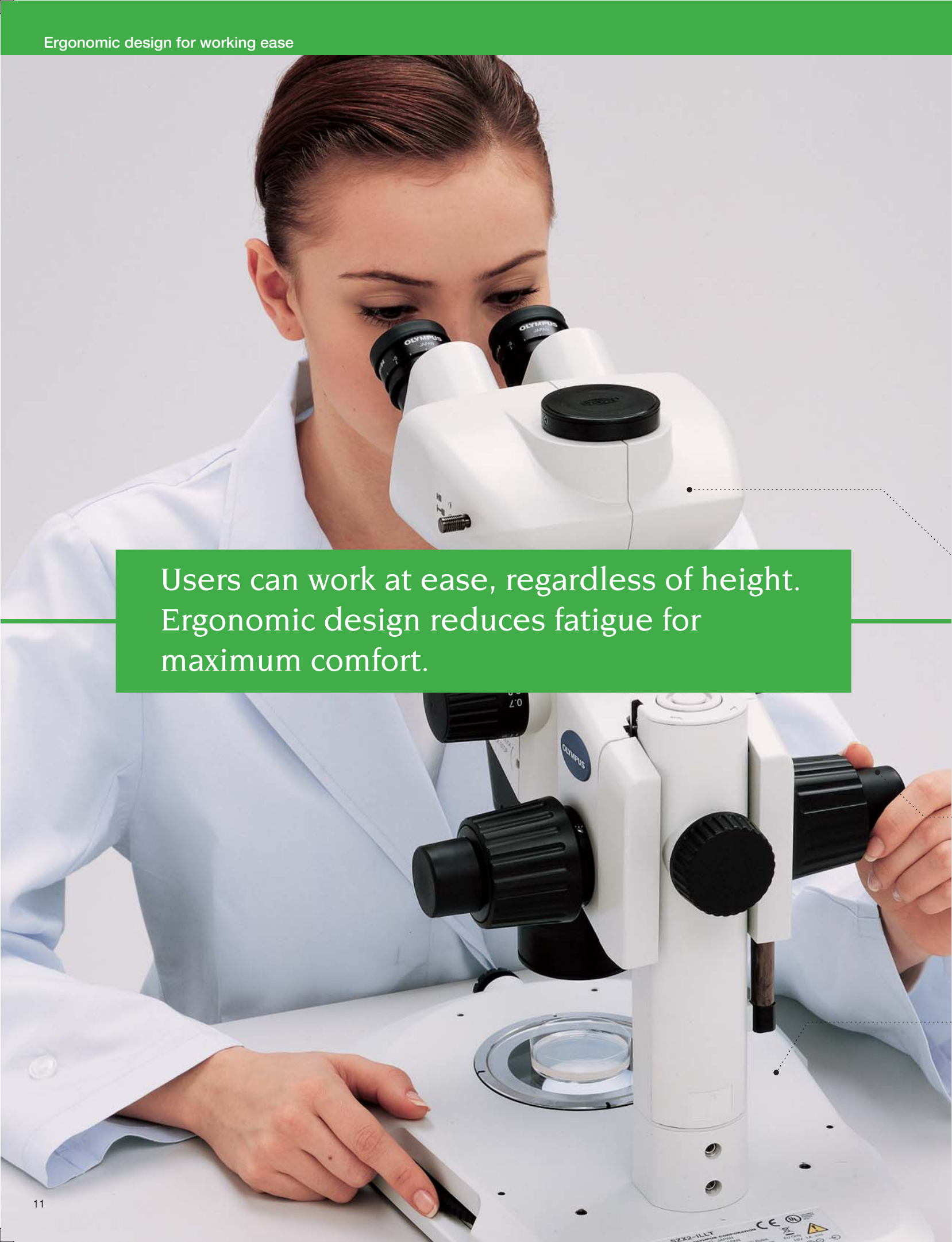

A woman with dark hair pulled back, wearing a white lab coat, is looking through the eyepieces of a white Olympus microscope. The microscope is positioned on a white surface. The woman's hands are visible, adjusting the microscope's controls. The background is a plain, light-colored wall.

Users can work at ease, regardless of height. Ergonomic design reduces fatigue for maximum comfort.

Optimal convergence angle plus tilting trinocular tube reduces fatigue.

The SZX2 brings greater working comfort with an observation tube featuring a convergence angle that relieves eyestrain. Moreover, the tilting trinocular tube and slim transmitted light illumination base enable natural posture for increased work efficiency during observation and manipulation tasks of long duration.

■ Observation tube with convergence angle relieves eyestrain

In cooperation with ophthalmologists, a correlation between stereomicroscope optical systems and eyestrain has been confirmed. Specifically, the angle between right and left lines of vision (convergence angle) is directly related to it. The SZX2 series provides an optimum convergence angle that is designed to allow users to observe in a natural position suited to the eye. This solution effectively eliminates eyestrain during long-time observation.



Observation tube with convergence angle

■ Tilting trinocular tube allows for natural posture, reduces fatigue

The tilting trinocular tube easily adjusts to the exact angle desired (5° – 45°). Regardless of desk height, the tilting trinocular tube assures a natural posture during long-time observation. As fatigue and stress are greatly relieved, oversights are avoided and work efficiency is increased.



Tilting trinocular tube

■ Designed for efficiency: zoom and focus handles

Close positioning of zoom handle and focus handle enable stress-free, blind operation. Fine adjustment of the focusing handle offers increased sensitivity for easy focusing at high magnification. In addition, the rigid body provides stable observation.



■ Slim design minimizes fatigue and lowers eyepoint

Illumination bases are designed not only to be easy to use but fatigue-free. The Slim LED transmitted light illumination base, at 41mm, lowers the eyepoint and makes access to specimens easier than ever. The wide stage surface easily accommodates Petri dishes and other specimen containers during observation and manipulation.



Slim LED transmitted light illumination base

The image is a collage of scientific and technological elements. At the top left, there are vertical light streaks. To the right, a jellyfish is shown in a light blue tone. Below that, a person's profile is seen looking at a computer monitor. In the center, a microscope is shown with a white body and black lenses. The text is overlaid on a dark purple rectangular background in the center. At the bottom, there are more microscope details, including the brand name 'OLYMPUS SZX16' and a focus knob with numbers like '10', '11.5', '0.7', and '0.9'.

From brightfield to fluorescence observation, several different specimens can be viewed at a high resolution recognized as leading the digital imaging world.

Microscope digital camera that reproduces true-to-life images

Each microscope digital camera in the SZX2 lineup captures images at high resolution. Olympus stereomicroscopes and digital cameras contribute to cutting-edge research in biology and medicine.

■ The high-performance Digital Camera (DP71) provides accurate and detailed image capture

Digital camera (DP71)

With the DP71, live images are displayed with 1360 x 1024 pixel resolution at a rate of 15 fps. Thanks to this smooth and fast display of live images, users now can perform observation without stress. By shifting the 1.45 mega pixel CCD, the camera delivers extremely high-resolution images equivalent to 12.5 million pixels. The high-speed image processing hardware captures these quality images in 3 seconds. Furthermore, when acquiring monochrome fluorescence images in gray scale, the custom gray-scale mode maintains a dynamic range with full RGB intensity.



Digital camera (DP20)

DP20 is a stand-alone type without the need of a PC. Featuring high-resolution imaging displayed at the high rate of 15fps for smooth, easy-to-view display of live specimen images. Digital zooming function wastes no time in focusing on selected areas. The RGB 24-bit (16.7 million colors) configuration will bring about rich, high-contrast streaming and video images that offer true-to-life colors. From various settings to the scales display, operations are done on the compact control box.



■ Motorized zoom and focus unit (SZX-FOA2)

Handling is made easier than ever, even when mounting a heavy unit like a large camera (maximum load of 14kg). Another advantage of this unit is that the user can stand away from the microscope for monitor observation. Manual coarse focusing and fine focusing are both possible when motorized control is engaged. A foot switch controls motorized zooming and focusing, which frees the user's hands for higher concentration on operation, improving overall work efficiency during observation and image capture.



■ Vertical observation

The revolving nosepiece matches the objective lens center to the zoom lens optical path for images with reduced aberration. Image shifting from focus change is eliminated for effective 3D rendering by software.



Coaxial light axis



Ordinary image (9x zoom)



Coaxial optical path image (9x zoom)

A wide array of accessories to observe various specimens

■ Stands and optional units

Standard stand (SZX2-ST)

This standard reflected light illumination stand supports observation conditions where no transmitted light is needed.



Universal stand type2 (SZ2-STU2)

Smooth horizontal movement and rotation enable specimen observation from various angles.



Large stand (SZX2-STL)

This stand provides a large working space to accommodate large specimens.

CO₂ incubator* (MI-IBCSZXF)

This CO₂ incubator is developed especially for the SZX2. Transparent glass heaters positioned above and below samples will create a stable environment within, equivalent to a CO₂ incubator. Long-time observation of specimens during cultivation is therefore possible. The glass heater above the chamber dries off condensation for a vivid imaging environment.



Thermo plate* (MATS-55SZX2A/ MATS-55SZX2B)

Compatible with the SZX2 only, this thermo plate has a temperature range that may be set from room temperature to 50° to keep the specimen warm.



Large stage plate (SZX-CL)

This stage plate attaches to the top of a transmitted light illumination base and can be detached for easy sterilization and other antiseptic procedures.



* Due to be launched in the summer of 2006.

■ Transmitted/Reflected light illumination base

Transmitted light guide adaptor (SZX-TLGAD)/ Light guide (LG-SF)

As the light guide LG-SF power source is mounted away from the transmitted light illumination base, increases in illuminator surface temperature are prevented.



Dual combination light guide (LG-DFI)

The SZX2 light guide can be mounted directly onto the focus drive, keeping the observation position properly illuminated even when focus is adjusted or when the specimen is exchanged.



Dual inter-lock light guide (LG-DI)

This light guide can be positioned as the observer likes for bright, even illumination - especially effective when high-contrast images are required. The spot lens HLL301* can be mounted.



Ring light guide (LG-R66)

With its ø66mm diameter mount, this ring light illuminator has been specially developed for stereomicroscope compatibility. When mounted with ring light adapter SZX-LGR66*/LGR66, it provides bright, uniformly lit images especially avoiding glaring reflections or obscuring shadows.



Coaxial illuminator (SZX2-ILLC16/SZX2-ILLC10*)

Used with the dual flexible light guide LG-DF*, this illuminator provides bright, even illumination without the need for centering adjustments to the lamp.



■ Accessories

Light beam splitter (SZX2-LBS)

The adapter allows a digital camera or other imaging unit to be attached on both sides of the SZX2-LBS body. The light path to the camera port is switched between 100% and 50% light. The 100% light path to the camera port enables image capturing of dark specimens.



Simple polarizer (SZX-PO) and analyzer (SZX2-AN)

This simple polarizer should be used with a transmitted light illumination base. It provides double-refractile image observation of such specimens as sea urchin larvae. Analyzer should be attached on the tip of objectives.



* Compatible with the SZX10 only.

SZX10



A zoom ratio of 1:10 is suitable for operations like specimen selection or dissection. SZX10 provides wide viewing and assures fewer oversights while relieving fatigue. Choose from a wide range of accessories to suit your sample needs.

SZX10: the highly versatile research stereomicroscope

This outstanding model assures cost-effective performance and faithful reproduction of images.

■ Distortion-free design provides accurate observation of images

Distortion-free design that has been constantly improved by Olympus over the years minimizes embossment of image plane and provides accurate images.

■ Maximum depth of field from the finest built-in AS zoom body

Closing the aperture increases the depth of field.

■ A wide array of accessories upgrades the system for various observation and documentation methods

The SZX10 responds to a wide range of accessories and achieves high performance during image capture and monitor observation. This versatile system can be used for a variety of applications.



Eyepoint adjuster (SZX-EPA)

Allows users to assume a natural posture during observation.



Side-by-side discussion tube (SZX-SDO)

Suitable for teaching because primary and secondary observers are seated beside one another.



Drawing attachment (SZX-DA)

Enables users to accurately draw the specimen for scientific study or illustration - a traditional alternative to photomicrography. The accessory can be mounted on either side of the microscope, depending on preference.



Binocular tubes (SZX-B130/TBI/B145)

These binocular tubes allow for variable eye points. Users will find observation can be done in a natural posture, thanks to the tilting head with an incline angle varying between 5° and 45°.



Coaxial fluorescence illumination stand (SZX-RFA)

This fluorescence unit allows observation of fluorescent proteins introduced into living cells.

Discussion tube (SZX-DO)

Face-to-face, discussion-style intermediate tube allows primary and secondary observers to sit opposite one another during specimen observation. The secondary observer can support primary observer more effectively in their tasks.

SZX16/SZX10 specifications

Item	Specifications					
	SZX16			SZX10		
Zoom microscope body	Zoom ratio: 16.4 (0.7x-11.5x) Magnification indication: 0.7/0.8/1/1.25/1.6/2/2.5/3.2/4/5/6.3/8/10/11.5			Zoom ratio: 10 (0.63x-6.3x) Magnification indication: 0.63/0.8/1/1.25/1.6/2/2.5/3.2/4/5/6.3		
	Zoom variable magnification system with parallel optical axis Zoom drive system: Horizontal handle Click-stop for various zoom positions incorporated					
	Built-in AS zoom body					
	Objective mounting: screw mount					
Objective	For SZX-ZB16			For SZX-ZB10		
	Objectives	N.A.	W.D. (mm)	Objectives	N.A.	W.D. (mm)
	SDFPLFL0.3X	0.045	141	DFPL0.5X-4	0.05	171
	SDFPLAPO0.5XPF	0.075	70.5	DFPL0.75X-4	0.075	116
	SDFPLAPO0.8X	0.12	81	DFPLAPO1X-4	0.1	81
	SDFPLAPO1XPF	0.15	60	SZX-ACH1X	0.1	90
	SDFPLAPO1.6XPF	0.24	30	DFPLAPO1.25X	0.125	60
	SDFPLAPO2XPFC	0.3	20	SZX-ACH1.25X-2	0.125	68
Eyepiece	WHN10X-H F.N. 22 WHSZ15X-H F.N. 16 WHSZ20X-H F.N. 12.5 WHSZ30X-H F.N. 7			WHSZ10X-H F.N. 22 WHSZ15X-H F.N. 16 WHSZ20X-H F.N. 12.5 WHSZ30X-H F.N. 7		
	<p>SZX2-TTR/SZX2-TTRPT: Tilting trinocular tube Convergence angle, Tilting angle: 5°-45°, 2 steps optical path selectable (TTR observation: straight port = 100:0, 50:50) (TTRPT observation: straight port = 100:0, 0:100) Interpupillary distance adjustment: 52-76mm</p> <p>SZX2-TR30/SZX2-TR30PT: 30 degree trinocular tube Convergence angle, Tilting angle: 30°, 2 steps optical path selectable (TR30 observation: straight port = 100:0, 50:50) (TR30PT observation: straight port = 100:0, 0:100) Interpupillary distance adjustment: 52-76mm</p>					
Observation tube	————			SZX-BI30: 30° binocular tube Tilting angle: 30° Interpupillary distance adjustment: 51-76		
	————			SZX-BI45: 45° binocular tube Tilting angle: 45° Interpupillary distance adjustment: 52-76		
	————			SZX-TBI: tilting binocular tube Tilting angle: 5-45° Interpupillary distance adjustment: 51-76		
Focusing assembly:	SZX2-FO: Focusing unit / focus: rack and pinion with roller guide (with torque adjustment ring for coarse focusing), optional counter balance, coarse handle stroke: 80mm, coarse handle stroke per rotation: 21mm, Load capacity: 0-10.0kg					
	SZX2-FOF: Fine focusing unit / focus: rack and pinion with roller guide (with torque adjustment ring for coarse focusing), coarse and fine coaxial handle, built-in counter balance, coarse handle stroke: 80mm, coarse handle stroke per rotation: 36.8mm, fine handle stroke: 80mm, fine handle stroke per rotation: 0.77mm, load capacity: 2.7-15.0kg					
	SZX2-FOFH: Fine focusing unit for heavy loading / focus: rack and pinion with roller guide (with torque adjustment ring for coarse focusing), coarse and fine coaxial handle, built-in gas spring counter balance, coarse handle stroke: 80mm, coarse handle stroke per rotation: 36.8mm, fine handle stroke: 80mm, fine handle stroke per rotation: 0.77mm, load capacity: 8.0-25.0kg					
	SZX-FOA2: Motorized focus unit / focus: rack and pinion with roller guide (with torque adjustment ring for coarse focusing), focusing stroke: 75mm, motorized focusing speed coarse: 1.5mm/sec fine: 0.3mm/sec load capacity: 2.7-15.0kg					
Stands	SZX-ST: Standard stand / Pillar height: 270mm, base dimension: 284(W)x335(D)x31(H)mm, Stage clips are mountable, with stage adapter fixing screw holes					
	SZX-STL: Large stand / Pillar height: 400mm, base dimension: 400(W)x350(D)x28(H)mm, Stage clips are mountable, with stage adapter fixing screw holes					

Transmitted illumination base specifications

Item	Specifications			
	SZX2-ILLT	SZX2-ILLB	SZX2-ILLK	SZX2-ILLD
Light source	LED (Average service life: Over 10,000 hrs by rated use) or 30W Halogen 6V30W HAL PHILIPS 5761 (average lamp service life: approx. 100 hours by rate use.)			
Light intensity adjustment	Continuously variable system			
Effective illuminated area	Brightfield: ø63mm Darkfield / Oblique: ø35mm	ø40mm		Brightfield: ø40mm Darkfield: ø35mm
Built-in filter	————	LBD, ND6, ND25 one for each	————	LBD (bright field only)
Add-on filter	————	————	ø45LBD filter	————
Illumination mode	Brightfield illumination Oblique illumination Darkfield illumination	Brightfield illumination Oblique illumination	Brightfield illumination Oblique illumination	Brightfield illumination Darkfield illumination
Contrast selection	————	2-step selection of High and Low	————	————
Cooling fan	Built-in			
The height of stage (from desk surface)	41mm		82mm	
Pillar height	270mm			
Weight	Approx. 3.7kg	Approx. 5.0kg	Approx. 4.6kg	Approx. 5.4kg
Power source	AC adaptor Built-in trance power unit			

Reflected light illuminators specifications

Type	Ring light guide LG-R66	Dual ring light guide LG-DFI/DI	Coaxial illuminator SZX2-ILLC16/10
Features	Bright, uniformly lit images without glaring reflections or obscuring shadows	Flexible illumination for any angle and position	Bright high contrast coaxial illumination. Effective for observing structure, such as imperfections on metal surfaces, patterns on IC or LCD
Illumination specification	Minimum WD: 30mm Mount diameter: 66mm Flexible part: 1000mm Attachment adapter*: SZX-LGR66 <small>*No adapter required for SZX16-LGR66 *Unable to attach to SDFPLAPO2XPFC/SDFPLAPO1.6XPF</small>	LG-DFI: Flexible part 900mm Inter-lock part 500mm LG-DI: Inter-lock part 500mm	Magnification factor: 1.5x Light guide: LG-DF Flexible part 1000mm 1/4 wave plate included
Light source specifications	Type: LG-PS2 Functions: Light intensity control and lamp ON/OFF control by external signal (DC0-5V), mechanical adjustment function Power consumption: 150W (350VA) Rated voltage: 100-120V/220-240V 50/60Hz Dimensions: 120(H)x120(H)x235(D)mm Weight: approx. 1.5kg		
Option	LG-R66PL: Polarizer/analyzer set for LG-R66	HILL301: spot lens LG-FAD: ø25 filter adapter	

Reflected light fluorescence illuminator

Type	Reflected light fluorescence illuminator/Fine focusing unit SZX2-RFA16	Reflected light fluorescence illuminator SZX-RFA
Illumination method	Near vertical reflected light fluorescence illumination which is corresponded to microscope zoom function Zooming of illuminator independent to zoom function of microscope body is possible.	Coaxial illumination
Filter turret	Five-position turret Maximum 5 sets of excitation/emission filter sliders are attachable. Comes with shutter that prevents flash-light caused by switching.	Four-step slide switch Maximum 3 mirror units are attachable. Comes with shutter that prevents flash-light caused by switching.
Filter holder slider	Three-step switch by shutter and two holes. ND filter can be attached at the holes.	
Filter slider	One excitation balancer can be attached.	—
Focusing assembly	Built-in Fine focusing unit / focus: rack and pinion with roller guide (with torque adjustment ring for coarse focusing), coarse and fine coaxial handle, built-in counter balance, coarse handle stroke: 69mm, coarse handle stroke per rotation: 36.8mm, fine handle stroke: 69mm, fine handle stroke per rotation: 0.77mm, load capacity: 2.7-15.0kg	—
Light source specifications	100W mercury lamp	

Total magnifications and actual field diameters of SZX2-ZB16

Objective	Eyepiece							
	WHN10X-H		WHSZ15X-H		WHSZ20X-H		WHSZ30X-H	
	total mag.	field diameter (mm)	total mag.	field diameter (mm)	total mag.	field diameter (mm)	total mag.	field diameter (mm)
SDFPLFL0.3X	2.1x-34.5x	ø104.8-ø6.4	3.2x-51.8x	ø76.2-ø4.6	4.2x-69x	ø59.5-ø3.6	6.3x-103.5x	ø33.3-ø2.0
SDFPLFL0.5XPF	3.5x-57.5x	ø62.9-ø3.8	5.3x-86.3x	ø45.7-ø2.8	7x-115x	ø35.7-ø2.2	10.5x-172.5x	ø20.0-ø1.2
SDFPLAPO0.8X	5.6x-92x	ø39.3-ø2.4	8.4x-138x	ø28.6-ø1.7	11.2x-184x	ø22.3-ø1.4	16.8x-276x	ø12.5-ø0.8
SDFPLAPO1XPF	7x-115x	ø31.4-ø1.9	10.5x-172.5x	ø22.9-ø1.4	14x-230x	ø17.9-ø1.1	21x-345x	ø10.0-ø0.6
SDFPLAPO1.6XPF	11.2x-184x	ø19.6-ø1.2*	16.8x-276x	ø14.3-ø0.9	22.4x-368x	ø11.2-ø0.7	33.6x-552x	ø6.3-ø0.4
SDFPLAPO2XPFC	14x-230x	ø15.7-ø1*	21x-345x	ø11.4-ø0.7*	28x-460x	ø8.9-ø0.5	42x-690x	ø5.0-ø0.3

Some vignetting may occur from optical characteristics. This occurs in observations at low magnification.

Total magnifications and actual field diameters of SZX2-ZB10

Objective	Eyepiece							
	WHSZ10X-H		WHSZ15X-H		WHSZ20X-H		WHSZ30X-H	
	total mag.	field diameter (mm)	total mag.	field diameter (mm)	total mag.	field diameter (mm)	total mag.	field diameter (mm)
DFPL0.5X-4	3.2x-31.5x	ø69.8-ø7.0	4.7x-47.3x	ø50.8-ø5.1	6.3x-63x	ø39.7-ø4	9.5x-94.5x	ø22.2-ø2.2
DFPL0.75X-4	4.7x-47.3x	ø46.6-ø4.7	7.1x-70.9x	ø33.9-ø3.4	9.4x-94.5x	ø26.5-ø2.6	14.2x-141.8x	ø14.8-ø1.5
DFPLAPO1X-4 SZX-ACH1X	6.3x-63x	ø34.9-ø3.5	9.5x-94.5x	ø25.4-ø2.5	12.6x-126x	ø19.8-ø2	18.9x-189x	ø11.1-ø1.1
DFPLAPO1.25X SZX-ACH1.25X-2	7.9x-78.9x	ø27.9-ø2.8	11.8x-118.1x	ø20.3-ø2	15.8x-157.5x	ø15.9-ø1.6	23.6x-236.3x	ø8.9-ø0.9
DFPL1.5X-4	9.5x-94.5x	ø23.3-ø2.3	14.2x-141.8x	ø16.9-ø1.7	18.9x-189x	ø13.2-ø1.3	28.4x-283.5x	ø7.4-ø0.7
DFPL2X-4	12.6x-126x	ø17.5-ø1.7	18.9x-189x	ø12.7-ø1.3	25.2x-252x	ø9.9-ø1	37.8x-378x	ø5.6-ø0.6

SZX16 System Diagram

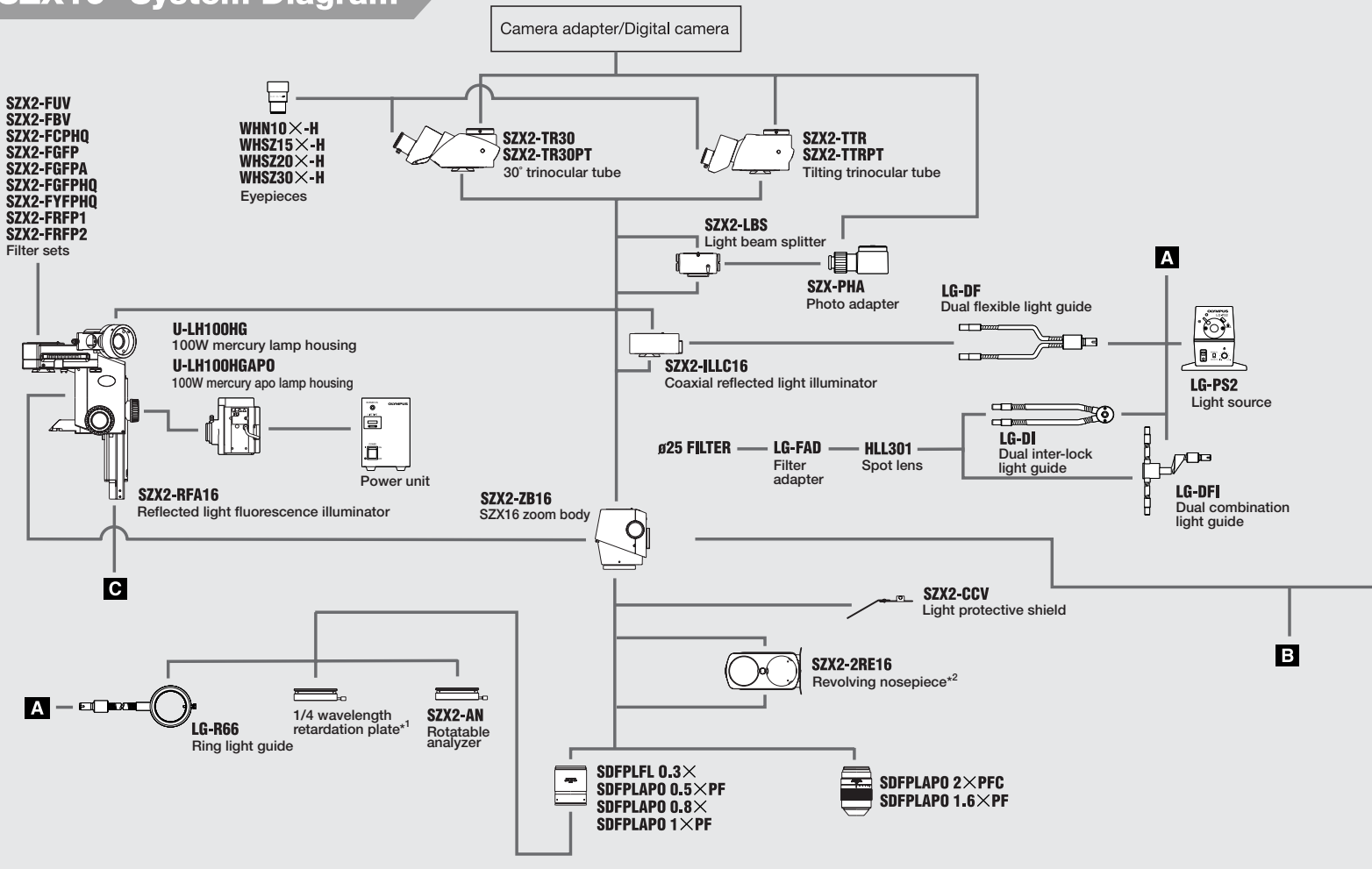

*1 Incorporated in SZX2-ILLC16 *2 Cannot be attached to SZX2-FO

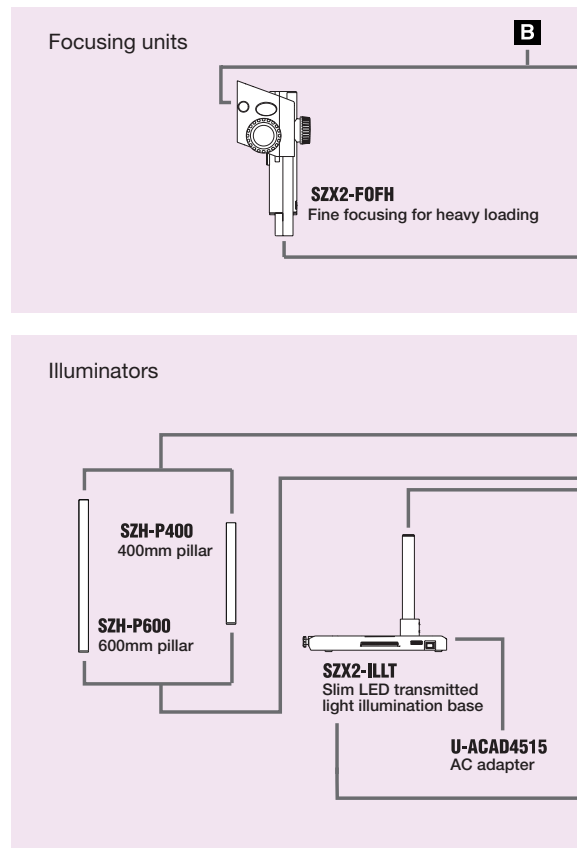
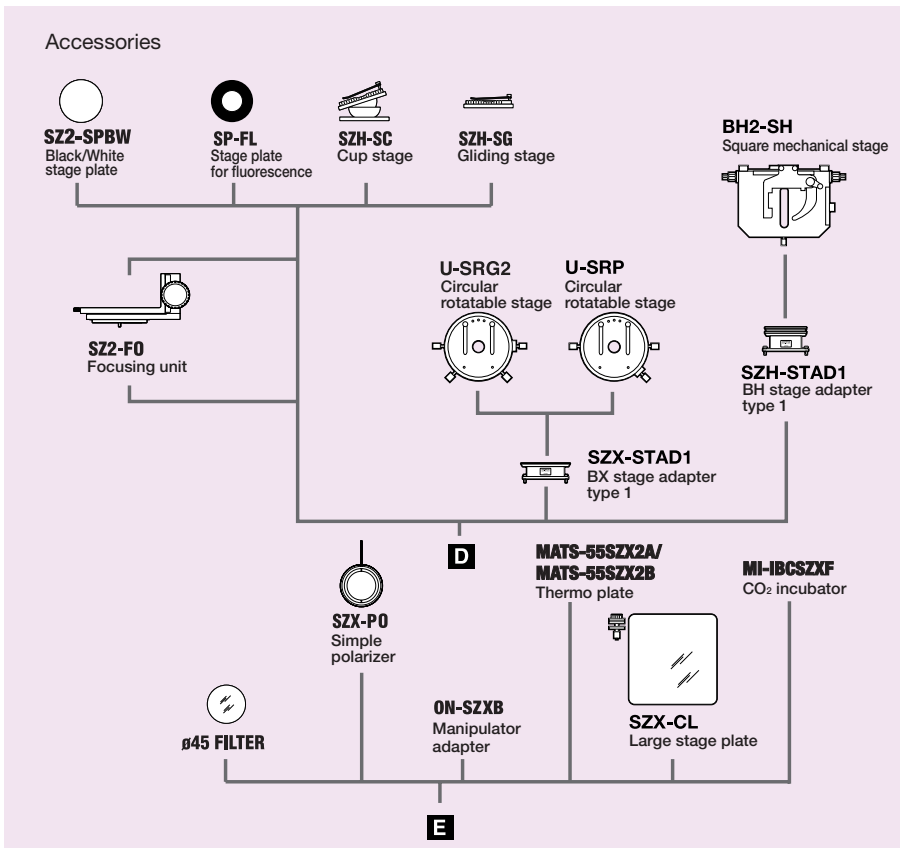

SZX10 System Diagram

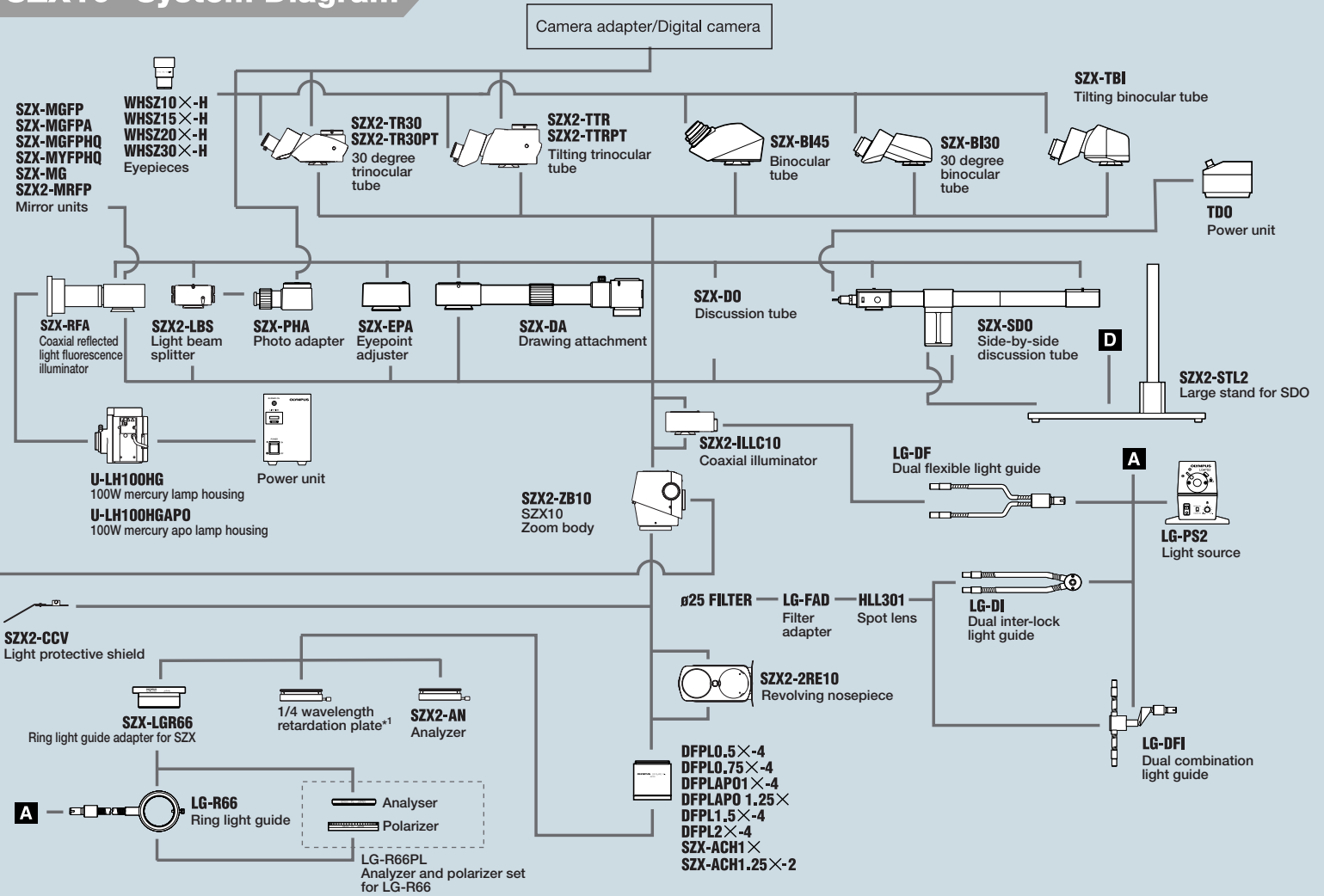

*1 Incorporated in SZX2-ILLC10

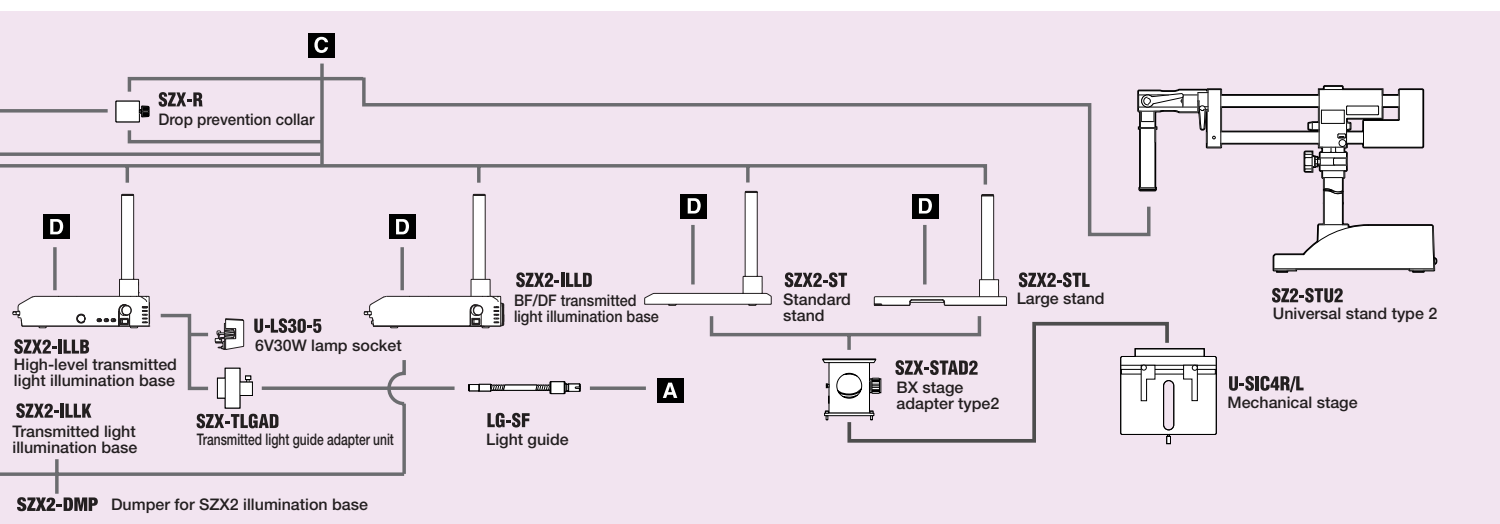
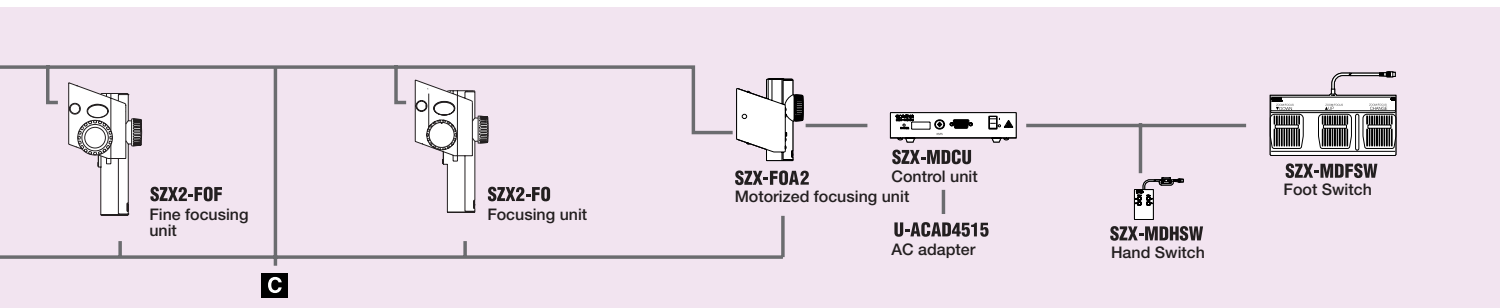

Images are courtesy of the following institutions:

RIKEN Brain Science Institute, Laboratory for Developmental Gene Regulation (page 1, left; page 3, lower left; pages 5, 7, & 8, lower right). RIKEN Center for Developmental Biology, Laboratory for Cell Asymmetry, Dr. Ayano Kawaguchi (page 3, lower right). Graduate School of Medicine and Faculty of Medicine, the University of Tokyo, Department of Cell Biology and Anatomy, Dr. Yasushi Okamoto (page 1, right; page 3, top; page 5, top right; page 7, top right). National Institute of Advanced Industrial Science and Technology, Research Institute for Cell Engineering, Neuronics Research Group (page 1, right).



Olympus has acquired ISO9001/ISO14001 certification for its quality/environmental management systems. In line with this qualification, newly developed SZX16/SZX10 products are manufactured without lead, hexavalent chromium, or cadmium. Olympus products contribute to society through their environmentally friendly designs.

Specifications are subject to change without any obligation on the part of the manufacturer.

OLYMPUS[®]

www.olympus.com

OLYMPUS CORPORATION
Shinjuku Monolith, 3-1, Nishi Shinjuku 2-chome, Shinjuku-ku, Tokyo, Japan
OLYMPUS LIFE AND MATERIAL SCIENCE EUROPA GMBH
Postfach 10 49 08, 20034, Hamburg, Germany
OLYMPUS SURGICAL & INDUSTRIAL AMERICA INC.
One Corporate Drive, Orangeburg, NY 10962, U.S.A.
OLYMPUS UK LTD.
2-8 Honduras Street, London EC1Y 0TX, United Kingdom.

OLYMPUS AUSTRALIA PTY. LTD.
31 Gilby Road, Mt. Waverley, VIC 3149, Melbourne, Australia.
OLYMPUS LATIN AMERICA, INC.
6100 Blue Lagoon Drive, Suite 390 Miami, FL 33126-2087, U.S.A.